

1600 SERIES ARTICLES / ARTICOLI DELLA SERIE 1600

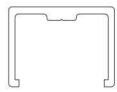

Upper track
Binario superiore

ART. 1604
8 02 0.01604



Section bar for ART. 1606
Profilato per ART. 1606

ART. 1600
8 02 0.01600



Lower track
Binario inferiore

ART. 1602
8 02 0.01602

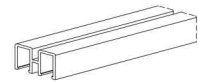

Plastic run
Canalina in plastica

ART. 1610
8 23 0.01610

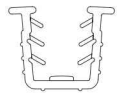

Gasket for 5 mm glass
Guarnizione per vetro 5 mm

ART. 1608
8 23 0.01608

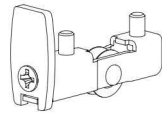

Slide
Scorrevole

ART. 1606

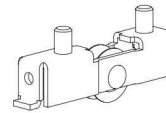

Slide
Scorrevole

ART. 1606/SP

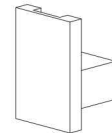

Cap
Tappo

ART. 1605/G



MEASUREMENTS DESCRIPTION / DESCRIZIONE MISURE

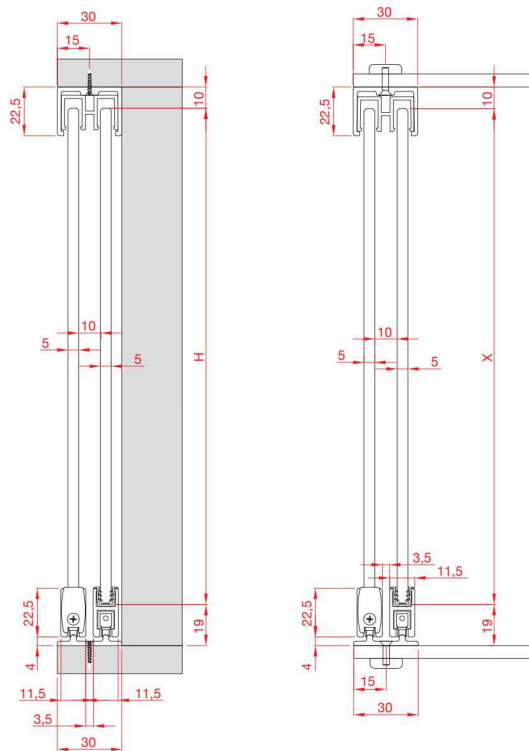

LOCKS SERIES / SERIE SERRATURE

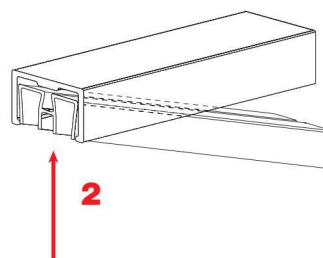
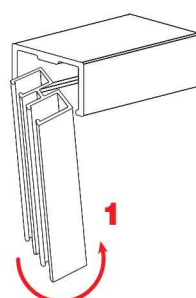

Assembly instructions for / Schema di montaggio

ART. 1610
8 23 0.01610