

## FLOAT

### PROFILS ET CONNECTEURS :

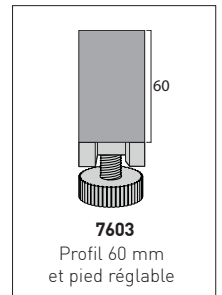
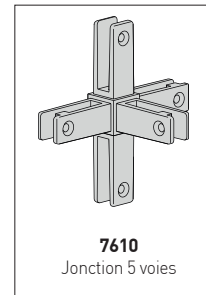
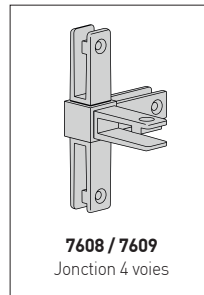
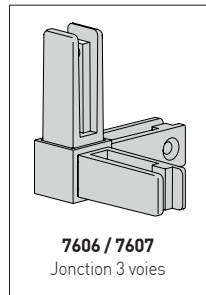
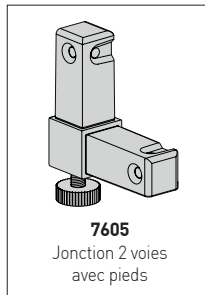
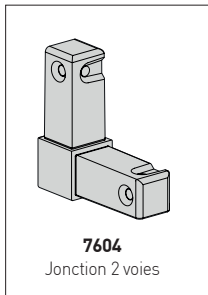
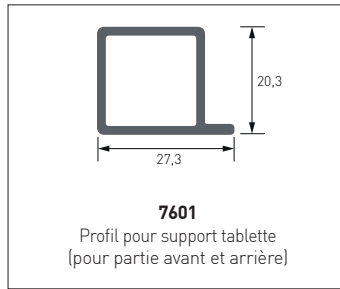
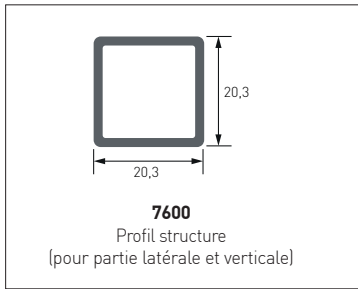

### PRINCIPE D'ASSEMBLAGE :

Le système Float permet de créer des modules plus ou moins complexes. Pour un montage optimal, veuillez prendre en compte que le placement de chaque connecteur est déterminé par le nombre de voies qui le composent. Vous trouverez ci-dessous des exemples de montage.

#### EXEMPLE 1 :

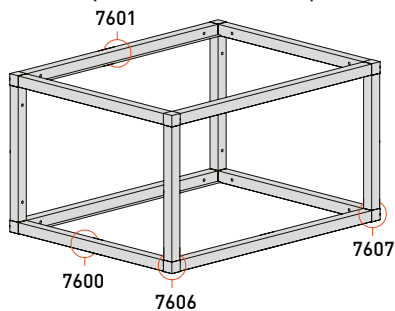

#### Ce module est composé de :

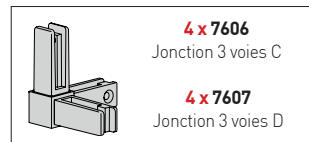
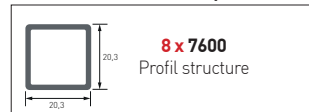

#### EXEMPLE 2 :

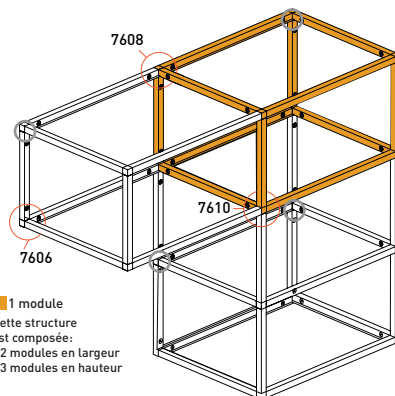

Nous conseillons la fixation au mur tous les 2 modules  
Voir sur le schéma ○

#### Ces modules sont composés de :

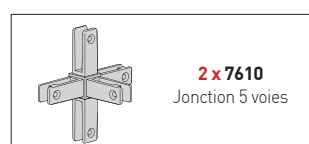
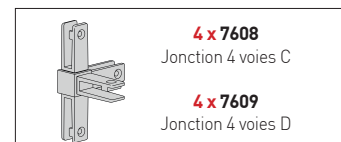
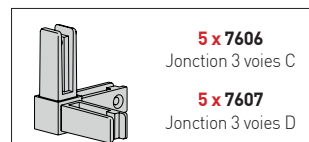
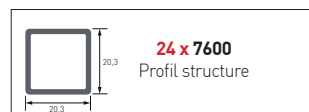

⚠ Les connecteurs 7606/7607 et 7608/7609 ont le même nombre de voies mais le placement du perçage diffère (côté droit/côté gauche).

### FIXATION AU MUR:

